

Betty 170x75

PREDINSTALACIJA
PREDINSTALLATION
PREINSTALLATION
VORINSTALLATION

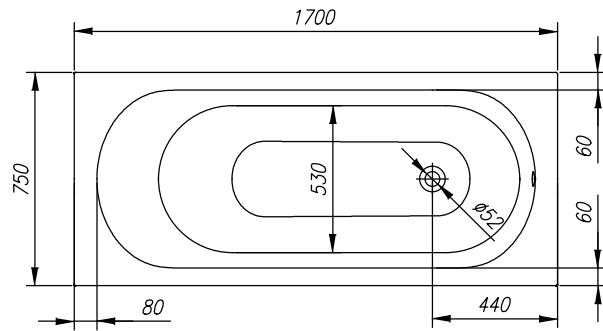
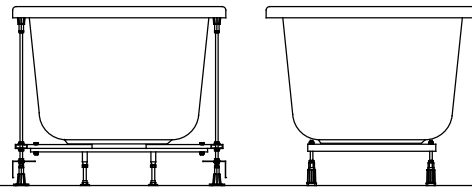
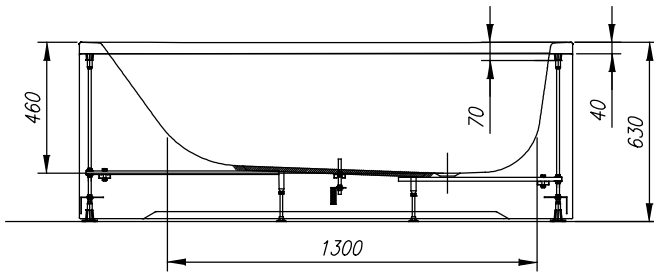

235 L

VOLUMEN
VOLUMEN
VOLUME
VOLUMEN

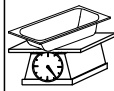

23 kg

TEŽA
TEŽINA
WEIGHT
GEWICHT

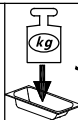

390 kg

MAX. OBREMENITEV
MAX. OBTEREČENJE
MAX. LOAD
MAX. BELASTUNG

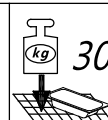

305 kg/m²

OBREMENITEV TAL
OBTEREČENJE PODA
FLOOR LOAD
BODENBELASTUNG



- Prostor za električni vodnik 3×2,5 mm², dolžine pribl. 1 m
- Mjesto za električni vodnik 3×2,5 mm², dužine cca. 1 m
- Spot for electrical cable 3×2,5 mm², length approx. 1 m
- Platz Stromkabel 3×2,5 mm², Länge ungefähr 1 m



- Prostor za električni vodnik 1×6 mm² za ozemljitev, dolžine pribl. 1,5 m
- Mjesto za električni vodnik 1×6 mm² za ozemljenje, dužine cca. 1,5 m
- Spot for electrical cable 1×6 mm² for earthing, length approx. 1,5 m
- Platz Stromkabel 1×6 mm² für Erdung, Länge ungefähr 1,5 m



- Priklop tople in hladne vode 1/2", min 0,2 Mpa, max 0,4 Mpa
- Priključak tople i hladne vode 1/2", min 0,2 Mpa, max 0,4 Mpa
- Connection of hot and cold water 1/2", min 0,2Mpa, max 0,4Mpa
- Anschluss Warm- und Kaltwasser 1/2", min 0,2 Mpa, max 0,4 Mpa



- Prostor za odtok Ø 50 mm
- Mjesto za odtok Ø 50 mm
- Drain spot Ø 50mm
- Abflussplatz Ø 50 mm



- Opcija-obloga
- Opcija-obloga
- Panel - option
- Möglichkeit - Schürze

priporočilo za vgradnjo
preporuka za ugradnju
installation recommendation
Einbauempfehlung

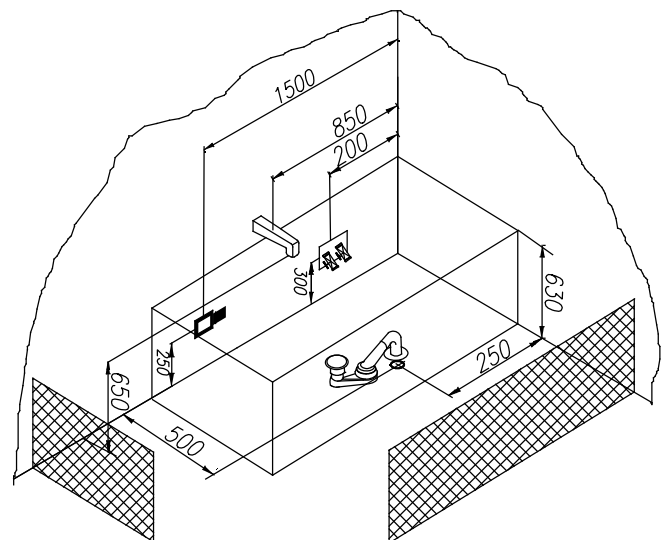

Priporočena prelivna garnitura
Preporuka prelivne garniture
Recommended overflow set
Vorgeschlagene Überlaufgarnitur

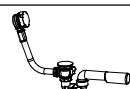

PAL 650

kopalna kad brez oblog - navodilo za vgradnjo
Kada bez obloge - upute za ugradnju
Bathtub without panel - installation instructions
Badewanne ohne Schürze - Einbauanleitung

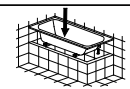

Nr. MK 03

Opcija podnožja za kadi brez obloge
Varianta postolja za kade bez obloge
Option of the built-in bathtub base
Möglichkeit des Sockels für die Badewannen ohne Schürze



Nr. MK 05
PKK 501

Kopalna kad z oblogo - navodilo za vgradnjo
Kada s oblogom - upute za ugradnju
Bathtub with panel - installation instructions
Badewanne mit Schürze - Einbauanleitung

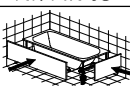

Nr. MK 01

Opcija podnožja za kadi z oblogo
Varianta postolja za kade sa oblogom
Option of the bathtub base with panel
Möglichkeit des Sockels für die Badewannen mit Schürze

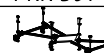

Nr. MK 12
CM 160-170

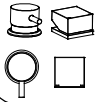

- MEŠALNI VENTIL TOPLA/HLADNA
- VENTIL ZA MIEŠANJE TOPLO/HLADNO
- MIXING VALVE HOT/COLD
- MISCHVENTIL WARM/KALT



- PREKLOPNIK ROČNA PRHA/IZLIV
- PREKIDAČ ZA RUČNI TUŠ/IZLJEV
- HAND SHOWER/SPOUT SELECTOR SWITCH
- SCHALTER FÜR HANDBRAUSE/AUSLAUF

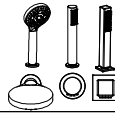

- ROČNA PRHA
- RUČNI TUŠ
- HAND SHOWER
- HANDBRAUSE

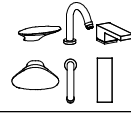

- IZLIV
- IZLJEVNIK
- SPOUT
- AUSLAUF

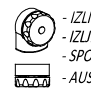

- IZLIV NA PRELIVNI GARNITURI
- IZLJEV NA PRELJEVNOM SETU
- SPOUT ON THE OVERFLOW SET
- AUSLAUF AN DER ÜBERLAUFGARNITUR

- OPCIJA ENOROČNA ARMATURA GEYSER
- OPCIJA JEDNORUČNA ARMATURA GEYSER
- OPTION ONE HAND FITTING GEYSER
- MÖGLICHKEIT EINWEG-ARMATUR GEYSER

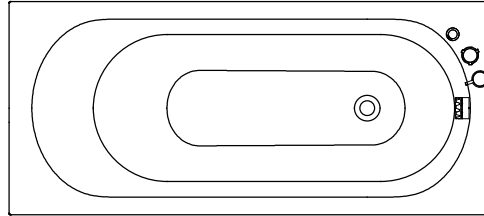
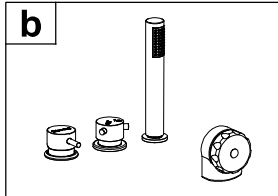

- OPCIJA ENOROČNA ARMATURA RAINDROP
- OPCIJA JEDNORUČNA ARMATURA RAINDROP
- OPTION ONE HAND FITTING RAINDROP
- MÖGLICHKEIT EINWEG-ARMATUR RAINDROP

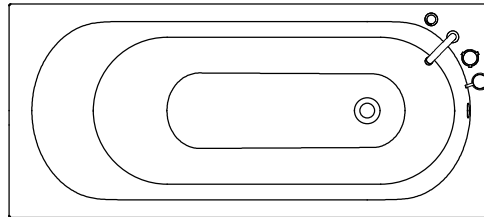
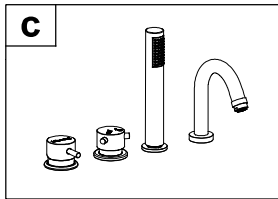

- OPCIJA ENOROČNA ARMATURA STREAM (CHR / BLACK)
- OPCIJA JEDNORUČNA ARMATURA STREAM (CHR / BLACK)
- OPTION ONE HAND FITTING STREAM (CHR / BLACK)
- MÖGLICHKEIT EINWEG-ARMATUR STREAM (CHR / BLACK)

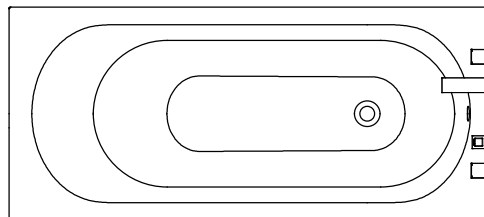
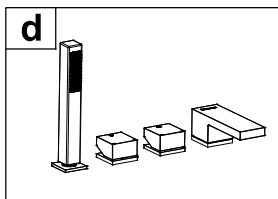

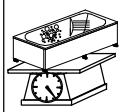
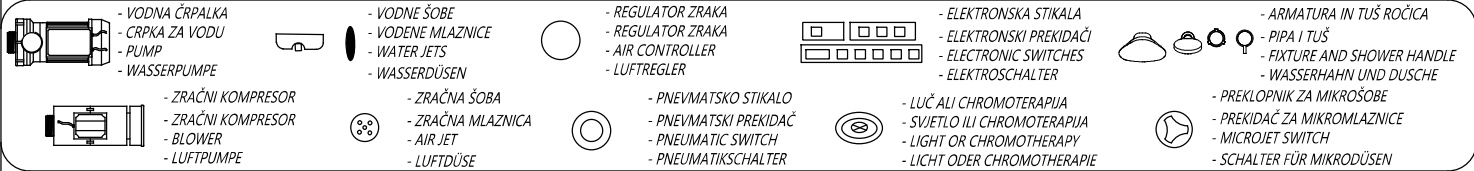

48 kg

TEŽA
 TEŽINA
 WEIGHT
 GEWICHT

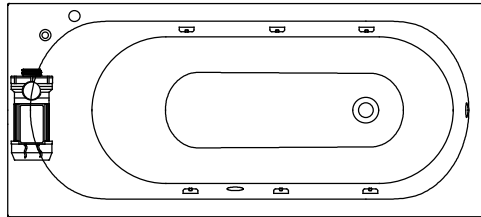

VODNI MASAŽNI SISTEM 1

- VODNA ČRPALKA P= 800W
- PNEVMATSKO STIKALO
- REGULATOR ZRAKA
- 6 VODNIH ŠOB

VODENI MASAŽNI SISTEM 1

- CRPKA ZA VODU P= 800W
- PNEVMATSKI PREKIDAČ
- REGULATOR ZRAKA
- 6 MLAZNICA ZA VODU

WATER MASSAGE SYSTEM 1

- PUMP P=800W
- PNEUMATIC SWITCH
- AIR CONTROLLER
- 6 WATER JETS

WASSERMASSEGESYSTEM 1

- WASSERPUMPE P = 800 W
- PNEUMATIKSCHALTER
- LUFTREGLER
- 6 WASSERDÜSEN

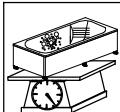

58 kg

TEŽA
 TEŽINA
 WEIGHT
 GEWICHT

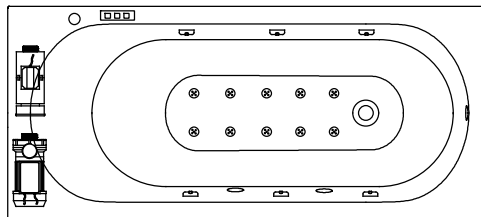

VODNI IN ZRAČNI
 MASAŽNI SISTEM

- VODNA ČRPALKA P= 800W
- ZRAČNI KOMPRESOR P=800W
- ELEKTRONSKO STIKALO
- 6 SUPER VODNIH ŠOB
- 10 ZRAČNIH ŠOB
- REGULATOR ZRAKA

VODENI I ZRAČNI
 MASAŽNI SISTEM

- CRPKA ZA VODU P= 800W
- ZRAČNI KOMPRESOR P=800W
- ELEKTRONSKI PREKIDAČ
- 6 SUPER MLAZNICA ZA VODU
- 10 ZRAČNIH MLAZNICA
- REGULATOR ZRAKA

WATER AND AIR
 MASSAGE SYSTEM

- PUMP P=800W
- BLOWER P=800W
- ELECTRONIC SWITCH
- 6 SUPER WATER JETS
- 10 AIR JETS
- AIR REGULATOR

WASSER UND LUFT
 MASSAGESYSTEM

- WASSERPUMPE P = 800 W
- LUFTPUMPE P = 800 W
- ELEKTROSCHALTER
- 6 SUPER-WASSERDÜSEN
- 10 LUFTDÜSEN
- LUFTREGLER

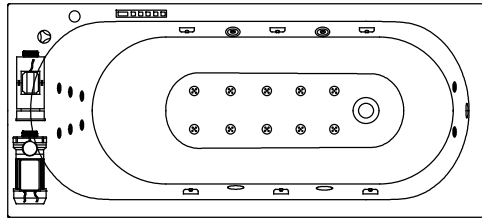
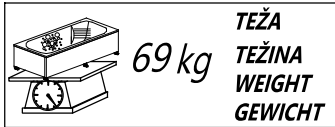
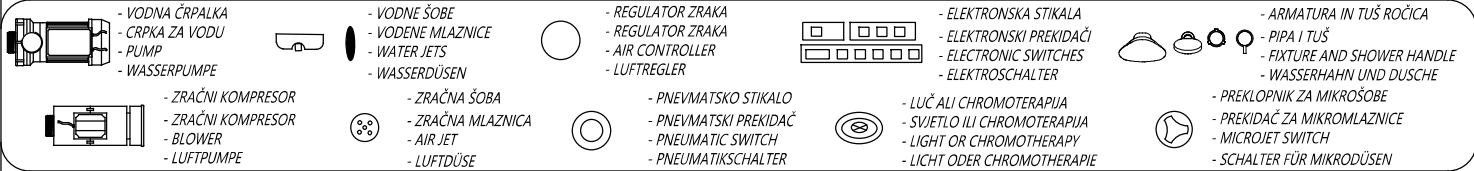

VITAL MASAŽNI SISTEM

- VODNA ČRPALKA P=1250W
- ZRAČNI KOMPRESOR P=800W
- GRELEC P=1500W
- ELEKTRONSKO STIKALO
- REGULATOR ZRAKA
- 6 SUPER VODNIH ŠOB
- 10 ZRAČNIH ŠOB
- OZON ZA DEZINFEKCIJU
- CHROMOTERAPIJA
- 6 MIKROŠOB ZA HRBET
- 2 MIKROŠOBI ZA NOGE

VITAL MASAŽNI SISTEM

- CRPKA ZA VODU P=1250W
- ZRAČNI KOMPRESOR P=800W
- GRUJAČ P=1500W
- ELEKTRONSKI PREKIDAČ
- REGULATOR ZRAKA
- 6 SUPER VODNIH MLAZNICA
- 10 ZRAČNIH MLAZNICA
- OZON ZA DEZINFEKCIJU
- CHROMOTERAPIJA
- 6 MIKROMLAZNICA ZA LEDA
- 2 MIKROMLAZNICE ZA NOGE

VITAL MASSAGE SYSTEM

- PUMP P=1250W
- BLOWER P=800W
- HEATER P=1500W
- ELECTRONIC SWITCH
- AIR CONTROLLER
- 6 SUPER WATER JETS
- 10 AIR JETS
- OZONE FOR DISINFECTION
- CHROMOTHERAPY
- 6 MICROJETS FOR BACK
- 2 MICROJETS FOR FEET

VITAL MESSAGESYSTEM

- WASSERPUMPE P = 1250 W
- LUFTPUMPE P = 800 W
- HEIZKÖRPER P = 1500 W
- ELEKTROSCHALTER
- LUFTREGLER
- 6 SUPER WASSERDÜSEN
- 10 LUFTDÜSEN
- OZON FÜR DESINFEKTION
- CHROMOTHERAPIE
- 6 MIKRODÜSEN FÜR RÜCKEN
- 2 MIKRODÜSEN FÜR FÜSSE

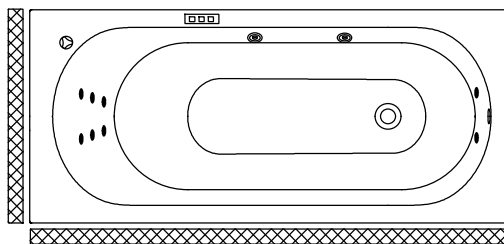

OPCIJE

- OPCIJA MIKROŠOBE 6 P=1250W

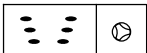

- OPCIJA DVE DODATNI MIKRO ŠOBI

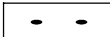

- OPCIJA CHROMOTERAPIJA



- POLOŽAJ OBLOG NA KOPALNI KADI

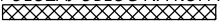

OPCIJE

- OPCIJA MIKROMLAZNICE 6 P=1250W



- OPCIJA DVIJE DODATNE MIKROMLAZNICE

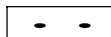

- OPCIJA CHROMOTERAPIJA



- POZICIJA OBLOGE NA KADI



OPTIONS

- OPTION 6 MICROJETS P=1250W

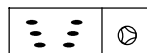

- OPTION TWO ADDITIONAL MICROJETS

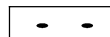

- OPTION CHROMOTHERAPY



- PANEL POSITIONS ON THE BATH



MÖGLICHKEITEN

- MÖGLICHKEIT MIKRODÜSEN 6 P = 1250 W

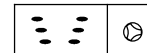

- MÖGLICHKEIT ZWEI ZUSÄTZLICHE MIKRODÜSEN



- MÖGLICHKEIT CHROMOTHERAPIE



- POSITION DER SHÜRZE FÜR BADEWANNE

